

KZ4000



# KZ4000

---

KZ4000

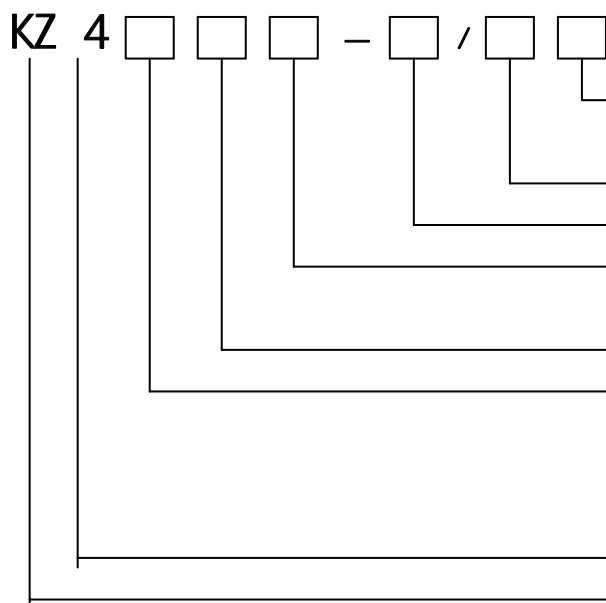
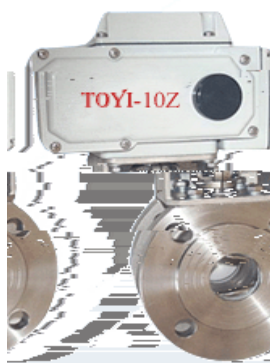

( ) —K  
( ) —B

DN  
PN

: —0  
—1  
: —0 —1  
O —0  
O —1  
V —2

KZ4011—16/100K PN1.6 DN100  
KZ4000—40/125B PN4.0 DN125

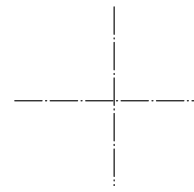
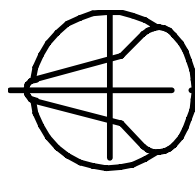
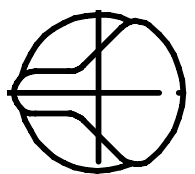
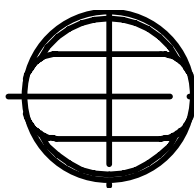
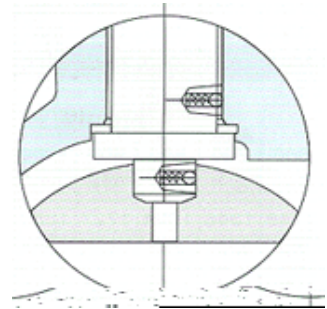
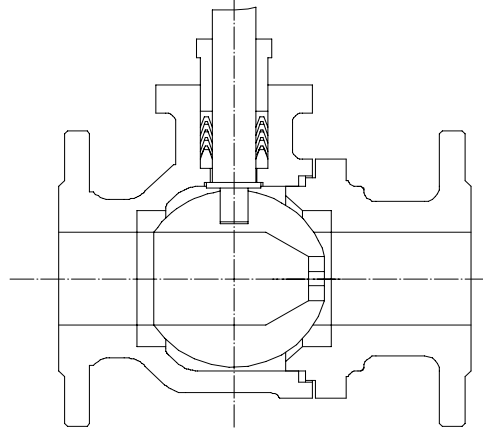
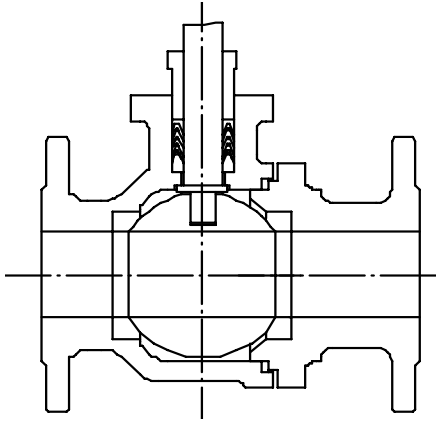

KZ4000

"

"

**Kv (Kv 0.8x Cv)**

	mm	20	25	32	40	50	65	80	100	125	150	200
	inch	0.75	1	1.25	1.5	2	2.5	3	4	5	6	8
	Cv	45	75	115	190	290	470	735	1170	1900	2900	4670
	Kv	40	63	100	160	250	400	630	1000	1600	2500	4000
	Cv		30	50	75	120	190	290	470	735	1170	1870
	Kv		25	40	63	100	160	250	400	630	1000	1600

	GB/T4213-92	JB/T7387-94	
	100	1	
	PN1.6 PN4.0 PN6.4	Cl ss150, 300, 600	
		RF FM	
	GB/T9113.1-2000	HG20592-97	JB/T79

		15	20	25	40	50	65	80	100	125	150	200	
	PN1. 6	132	142	150	180	200	220	250	280	320	360	400	
	PN4. 0	132	142	150	180	200	225	250	280	325	365	415	
	PN6. 4	140	150	160	195	215	240	265	300	345	385	440	
H		55	65	70	85	90	100	110	125	150	170	200	
DCL UN C Nucrom	L		399	399	399	399	424	427	446	456	471	491	610
			499	499	499	499	524	527	546	556	571	591	710
			569	569	569	569	594	597	616	626	641	661	800
	D	207	207	207	207	207	207	256	256	256	256	380	
		15. 5	17	17	18	19. 5	22. 5	34. 5	39	45	69. 5	104	
PSQ	L		522	522	522	522	547	550	635	645	660	766	856
			622	622	622	622	647	650	735	745	760	866	956
			692	692	692	692	717	720	805	815	830	936	1046
	D	125	125	125	125	125	125	200	200	200	250	250	
		18	19. 5	19. 5	20. 5	22	25	38. 5	43	49	87	111	
HQ	L		535	535	535	535	560	563	575	612	627	662	758
			635	635	635	635	660	663	678	712	727	762	858
			705	705	705	705	730	733	745	782	797	832	948
	D	231	231	231	231	231	261	261	285	285	285	325	
		22	23. 5	23. 5	24. 5	26	30	38. 5	47	54	79	106	
	L		427	427	450	450	475	498	548	553	625	645	782
			527	527	550	550	575	598	648	563	725	745	882
			597	597	620	620	645	668	718	723	795	815	972
	D	203	203	222	222	294	300	380	380	450	450	603	
		15	16	18	19	23	28	44	47	75	99	106	